

**NOTES:**

1. ALL PRODUCTS AND MATERIALS ARE REQUIRED TO BE NSF-61 COMPLIANT.
2. METER, METER COUPLING AND OUTSIDE REMOTE ARE SUPPLIED AND INSTALLED BY HRWC.
3. ALL PIPE MATERIAL IS REQUIRED TO BE TYPE K COPPER TUBING TO ASTM B88.
4. FOR PEX<sub>a</sub> WATER SERVICE CONNECTIONS, USE ASTM 2080 COMPRESSION SLEEVE FITTING TO TRANSITION TO THE COPPER TUBING OF THE WATER METER ARRANGEMENT.
5. WATER METER TO BE INSTALLED WITHIN 1200 mm OF WHERE THE SERVICE CONNECTION ENTERS THE BUILDING.
6. ARRANGEMENT IS TO BE NO LESS THAN 450 mm AND NO MORE THAN 750mm FROM THE FLOOR.
7. MINIMUM OF 1200 mm STRAIGHT LENGTH OF TYPE K COPPER TUBING DOWNSTREAM OF THE WATER METER. SECURE THE COPPER TUBING TO THE WALL OR FLOOR.
8. THE ARRANGEMENT IS REQUIRED TO BE HORIZONTALLY LEVEL AND HAVE SUFFICIENT ROOM FOR ACCESS.
9. A SHUT OFF VALVE MAY BE SUBSTITUTED FOR THE WATER METER VALVE.
10. PROVIDE 1/2" CONDUIT THROUGH FOUNDATION OR EXTERIOR WALL CLOSEST TO THE WATER METER FOR PURPOSE OF INSTALLING AN OUTSIDE REMOTE. PROVIDE SOLID 22 GAUGE, 3 OR 4 STRANDED CONDUCTOR WIRE FROM THE WATER METER TO THE EXTERIOR LOCATION FOR THE OUTSIDE REMOTE.
11. INSTALL OUTSIDE REMOTE ON THE DRIVEWAY SIDE OF THE BUILDING OR WHERE DIRECTED BY HRWC.
12. ALL COMPONENTS ILLUSTRATED MUST BE INSTALLED PRIOR TO THE WATER METER INSTALLATION.
13. THE BUILDING IS REQUIRED TO BE ROOF TIGHT, WITH EXTERIOR SIDING INSTALLED, AND THE CURB STOP AND SERVICE BOX ARE TO BE PLUMB AND LEVEL WITH FINISHED LANDSCAPING PRIOR TO WATER METER INSTALLATION.

No.	DESCRIPTION	DATE	BY	CHKD
2	NEW DETAIL FOR 2018	07 05 18	ST	JD
1	NEW DETAIL FOR 2017	08 05 17	ST	KG

**NOTE:**  
ALL DIMENSIONS SHOWN IN MILLIMETERS, UNLESS OTHERWISE NOTED.



PROJECT		PROFILE OF 15mm, 19mm & 25mm (5/8", 3/4" & 1") WATER METER ARRANGEMENT	
DRAWN	J.W./SJT	SCALE	(PLAN)
CHECKED	J.D.	SCALE	(PROFILE) N.T.S.
APPROVED	K.G.	DATE	08/05/17
PROJECT No.			
DWG. No. HWSD-001 (2018)			

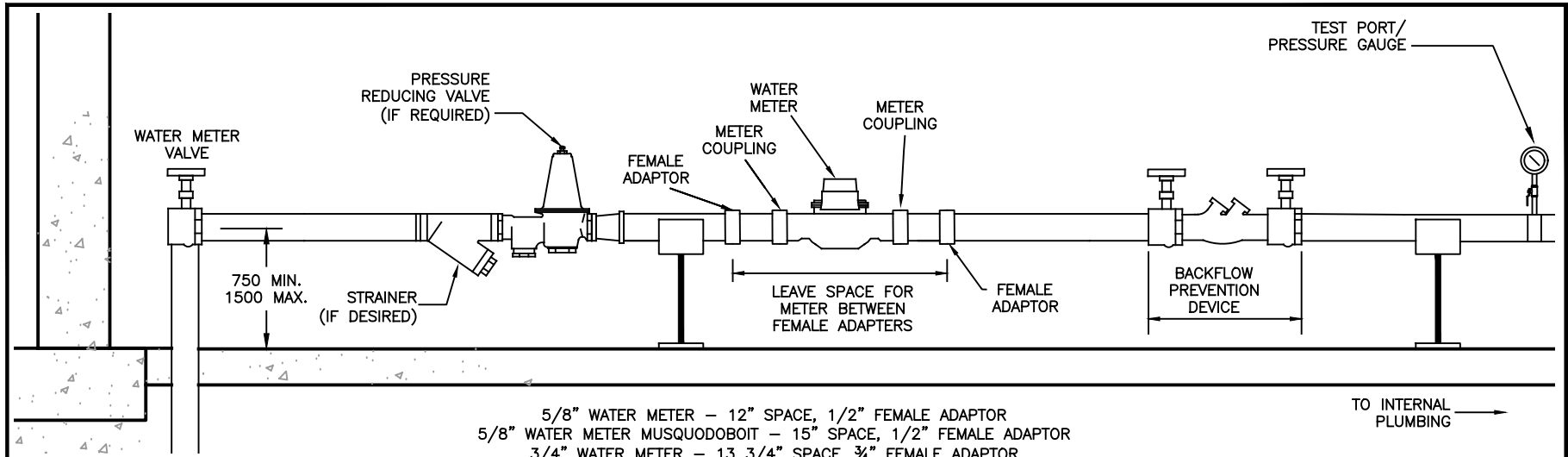

5/8" WATER METER – 12" SPACE, 1/2" FEMALE ADAPTOR  
 5/8" WATER METER MUSQUODOBOIT – 15" SPACE, 1/2" FEMALE ADAPTOR  
 3/4" WATER METER – 13 3/4" SPACE, 3/4" FEMALE ADAPTOR  
 1" WATER METER – 15 3/4" SPACE, 1" FEMALE ADAPTOR

**NOTES:**

1. ALL PRODUCTS AND MATERIALS ARE REQUIRED TO BE NSF61 COMPLIANT.
2. METER, METER COUPLING AND OUTSIDE REMOTE ARE SUPPLIED BY HRWC.
3. ALL PIPE MATERIAL IS REQUIRED TO BE TYPE K COPPER TUBING TO ASTM B88,
4. FOR PEX<sub>d</sub> WATER SERVICE CONNECTIONS, USE ASTM 2080 COMPRESSION SLEEVE FITTING TO TRANSITION TO THE COPPER TUBING OF THE WATER METER ARRANGEMENT.
5. WATER METER TO BE INSTALLED WITHIN 1200 mm OF WHERE THE SERVICE CONNECTION ENTERS THE BUILDING.
6. ARRANGEMENT IS TO BE NO LESS THAN 750 mm AND NO MORE THAN 1500 mm FROM THE FLOOR.
7. MINIMUM OF 1200 mm STRAIGHT LENGTH OF TYPE K COPPER TUBING DOWNSTREAM OF SHUT OFF VALVE #2. SECURE THE COPPER TUBING TO THE WALL OR FLOOR.
8. THE ARRANGEMENT IS REQUIRED TO BE HORIZONTALLY LEVEL AND HAVE SPECIFIED ROOM FOR ACCESS.
9. A SHUT OFF VALVE MAY BE SUBSTITUTED FOR THE WATER METER VALVE.
10. PROVIDE 1/2" CONDUIT THROUGH FOUNDATION OR EXTERIOR WALL CLOSEST TO THE WATER METER FOR PURPOSE OF INSTALLING AN OUTSIDE REMOTE PROVIDE SOLID 22 GAUGE, 3 OR 4 STRANDED CONDUCTOR WIRE FROM THE WATER METER TO THE EXTERIOR LOCATION FOR THE OUTSIDE REMOTE.
11. INSTALL OUTSIDE REMOTE ON THE DRIVEWAY SIDE OF THE BUILDING OR WHERE DIRECTED BY HRWC.
12. ALL COMPONENTS ILLUSTRATED MUST BE INSTALLED PRIOR TO THE WATER METER INSTALLATION
13. THE BUILDING IS REQUIRED TO BE ROOF TIGHT, WITH EXTERIOR SIDING INSTALLED, AND THE CURB STOP AND SERVICE BOX ARE TO BE PLUMB AND LEVEL WITH FINISHED LANDSCAPING PRIOR TO WATER METER INSTALLATION.
14. TEST PORT/PRESSURE GAUGE TO BE LOCATED DOWNSTREAM OF METER AND BACKFLOW PREVENTION DEVICE ARRANGEMENT.

2	NEW DETAIL FOR 2018	04 27 18	ST	JD	
1	NEW DETAIL FOR 2017	08 05 17	ST	KG	
No.	DESCRIPTION	DATE	BY	CHKD	

**NOTE:**  
 ALL DIMENSIONS SHOWN IN MILLIMETERS,  
 UNLESS OTHERWISE NOTED.



<b>PROJECT</b>		PROFILE OF 15mm, 19mm & 25mm (5/8", 3/4" & 1") WATER METER & BACKFLOW PREVENTION DEVICE ARRANGEMENT	
DRAWN	S.T.	SCALE	(PLAN)
CHECKED	J.D.	SCALE	(PROFILE) N.T.S.
APPROVED	K.G.	DATE	08/05/17
PROJECT No.			
DWG. No.		HWSD – 002	

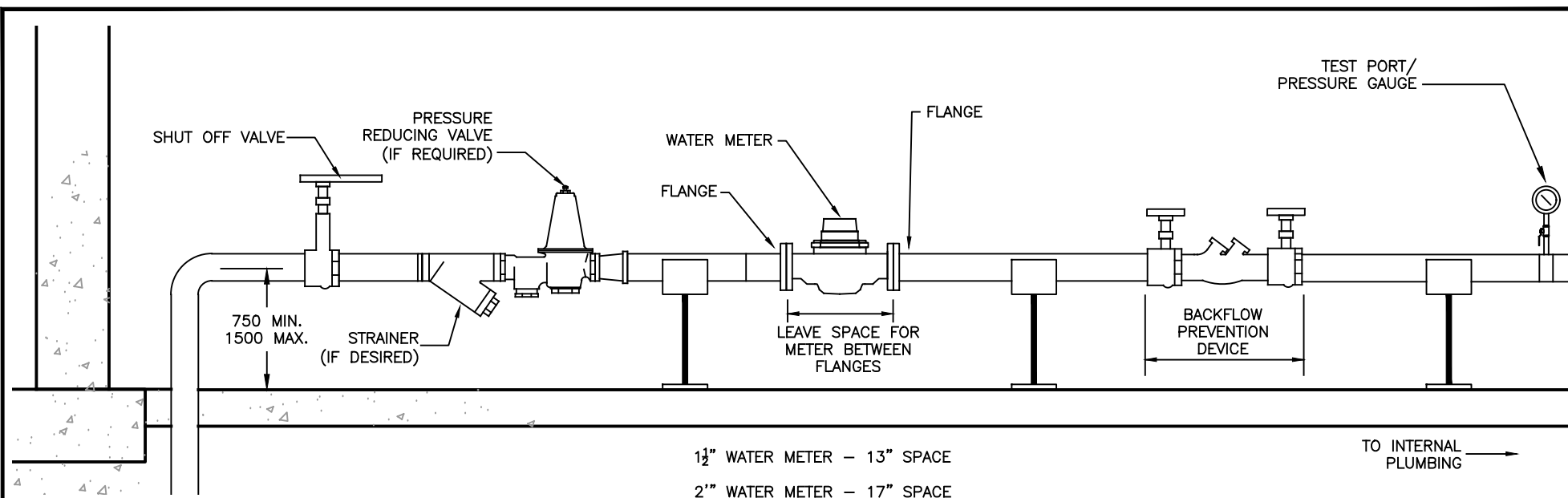

**NOTES:**

1. ALL PRODUCTS AND MATERIALS ARE REQUIRED TO BE NSF61 COMPLIANT.
2. METER AND OUTSIDE REMOTE ARE SUPPLIED BY HRWC.
3. ALL PIPE MATERIAL IS REQUIRED TO BE TYPE K COPPER TUBING TO ASTM B88, OR DUCTILE IRON, SPECIAL CLASS 52/54 TO AWWA C151 OR STAINLESS STEEL TUBING AWWA C220.
4. FOR PEX<sub>a</sub> WATER SERVICE CONNECTIONS, USE ASTM 2080 COMPRESSION SLEEVE FITTING TO TRANSITION TO THE COPPER TUBING OF THE WATER METER ARRANGEMENT.
5. WATER METER TO BE INSTALLED WITHIN 1200 mm OF WHERE THE SERVICE CONNECTION ENTERS THE BUILDING.
6. ARRANGEMENT IS TO BE NO LESS THAN 750 mm AND NO MORE THAN 1500mm FROM THE FLOOR.
7. MINIMUM OF 1200 mm STRAIGHT LENGTH OF TYPE K COPPER TUBING OR DUCTILE IRON DOWNSTREAM OF THE WATER METER. SECURE THE PIPING TO THE WALL OR FLOOR.
8. THE ARRANGEMENT IS REQUIRED TO BE HORIZONTALLY LEVEL AND HAVE SPECIFIED ROOM FOR ACCESS
9. PROVIDE 1/2" CONDUIT THROUGH FOUNDATION OR EXTERIOR WALL CLOSEST TO THE WATER METER FOR PURPOSE OF INSTALLING AN OUTSIDE REMOTE. PROVIDE SOLID 22 GAUGE, 3 OR 4 STRANDED CONDUCTOR WIRE FROM THE WATER METER TO THE EXTERIOR LOCATION FOR THE OUTSIDE REMOTE.
10. INSTALL OUTSIDE REMOTE ON THE DRIVEWAY SIDE OF THE BUILDING OR WHERE DIRECTED BY HRWC.
11. ALL COMPONENTS ILLUSTRATED MUST BE INSTALLED PRIOR TO THE WATER METER INSTALLATION.
12. THE BUILDING IS REQUIRED TO BE ROOF TIGHT, WITH EXTERIOR SIDING INSTALLED, AND THE CURB STOP AND SERVICE BOX ARE TO BE PLUMB AND LEVEL WITH FINISHED LANDSCAPING PRIOR TO WATER METER INSTALLATION.
13. TEST PORT/PRESSURE GAUGE TO BE LOCATED DOWNSTREAM OF METER AND BACKFLOW PREVENTION DEVICE ARRANGEMENT.

No.	DESCRIPTION	DATE	BY	CHKD
3	NEW DETAIL FOR 2022	03/14/22	ST	JC
2	NEW DETAIL FOR 2018	04/27/18	ST	JD
1	NEW DETAIL FOR 2017	08/05/17	ST	KG

**NOTE:**  
ALL DIMENSIONS SHOWN IN MILLIMETERS, UNLESS OTHERWISE NOTED.



<b>PROJECT</b>		<b>PROFILE OF 38 mm &amp; 50 mm (1-1/2" &amp; 2") WATER METER &amp; BACKFLOW PREVENTION DEVICE</b>	
<b>DRAWN</b>	S.T.	<b>SCALE (PLAN)</b>	
<b>CHECKED</b>	J.D.	<b>SCALE (PROFILE)</b>	N.T.S.
<b>APPROVED</b>	K.G.	<b>DATE</b>	08/05/17
<b>PROJECT No.</b>			
<b>DWG. No.</b>		HWSD - 003	

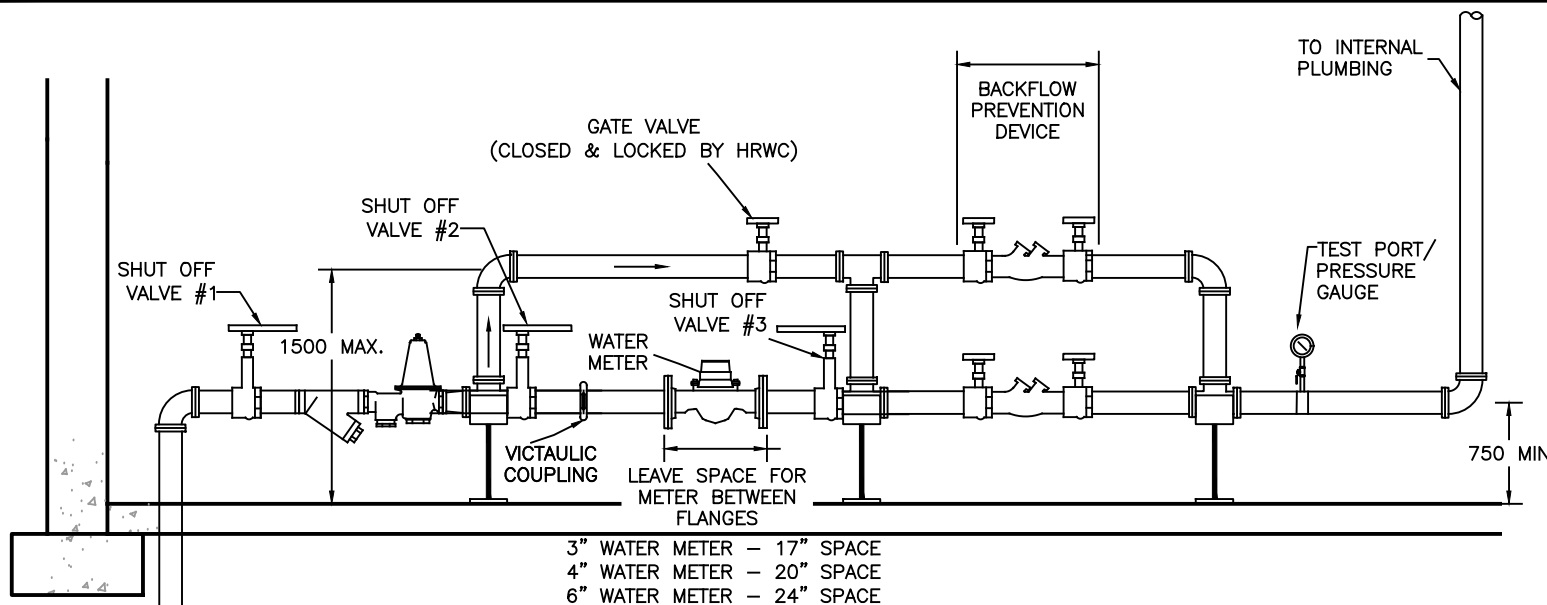

**NOTES:**

1. ALL PRODUCTS AND MATERIALS ARE REQUIRED TO BE NSF61 COMPLIANT.
2. WATER METER AND OUTSIDE REMOTE ARE SUPPLIED BY HRWC.
3. ALL PIPE MATERIAL IS REQUIRED TO BE TYPE K COPPER TUBING TO ASTM B88, OR DUCTILE IRON, SPECIAL CLASS 52/54 TO AWWA C151 OR STAINLESS STEEL TUBING TO AWWA C220.
4. FOR PEX<sub>a</sub> WATER SERVICE CONNECTIONS, USE ASTM 2080 COMPRESSION SLEEVE FITTING TO TRANSITION TO THE COPPER TUBING OF THE WATER METER ARRANGEMENT.
5. WATER METER TO BE INSTALLED WITHIN 1200 mm OF WHERE THE SERVICE CONNECTION ENTERS THE BUILDING.
6. ARRANGEMENT IS TO BE NO LESS THAN 750 mm AND NO MORE THAN 1500mm FROM THE FLOOR.
7. PROVIDE STRAIGHT LENGTH OF PIPE EQUAL TO 5 TIMES THE DIAMETER OF THE PIPE UPSTREAM AND DOWNSTREAM OF THE WATER METER.
8. THE ARRANGEMENT IS REQUIRED TO BE HORIZONTALLY LEVEL AND HAVE SPECIFIED ROOM FOR ACCESS.
9. PROVIDE 1/2" CONDUIT THROUGH FOUNDATION OR EXTERIOR WALL CLOSEST TO THE WATER METER FOR PURPOSE OF INSTALLING AN OUTSIDE REMOTE. PROVIDE SOLID 22 GAUGE, 3 OR 4 STRANDED CONDUCTOR WIRE FROM THE WATER METER TO THE EXTERIOR LOCATION FOR THE OUTSIDE REMOTE.
10. INSTALL OUTSIDE REMOTE ON THE DRIVEWAY SIDE OF THE BUILDING OR WHERE DIRECTED BY HRWC.
11. ALL COMPONENTS ILLUSTRATED MUST BE INSTALLED PRIOR TO THE WATER METER INSTALLATION.
12. THE BUILDING IS REQUIRED TO BE ROOF TIGHT, WITH EXTERIOR SIDING INSTALLED, AND THE CURB STOP AND SERVICE BOX ARE TO BE PLUMB AND LEVEL WITH FINISHED LANDSCAPING PRIOR TO WATER METER INSTALLATION.
13. DETAILS OF THRUST RESTRAINT SYSTEM AND PIPE SUPPORTS TO BE DESIGNED AND STAMPED BY THE DESIGN ENGINEER.
14. TEST PORT/PRESSURE GAUGE TO BE LOCATED DOWNSTREAM OF METER AND BACKFLOW PREVENTION DEVICE ARRANGEMENT.

No.	DESCRIPTION	DATE	BY	CHKD
3	NEW DETAIL FOR 2022	03/14/22	ST	JC
2	NEW DETAIL FOR 2018	04/27/18	ST	JD
1	NEW DETAIL FOR 2017	08/05/17	ST	KG

**NOTE:**  
ALL DIMENSIONS SHOWN IN MILLIMETERS,  
UNLESS OTHERWISE NOTED.



<b>PROJECT</b>		PROFILE OF 75mm (3") AND GREATER WATER METER AND BACKFLOW PREVENTION DEVICE BY-PASS ARRANGEMENT	
DRAWN	S.T.	SCALE	(PLAN)
CHECKED	J.D.	SCALE	(PROFILE) N.T.S.
APPROVED	K.G.	DATE	08/05/17
PROJECT No.			
DWG. No.		HWSD - 004	

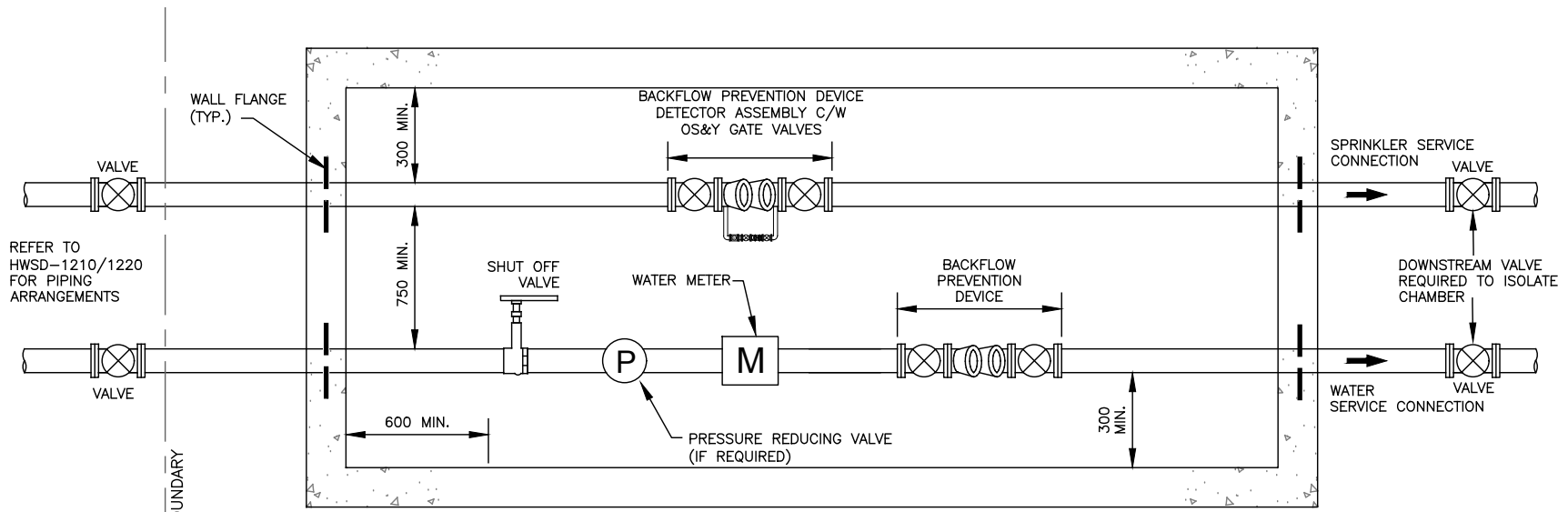

NOTES:

1. ALL NOTED DIMENSIONS / SPACING REQUIREMENTS WITH REGARDS TO CHAMBER WALLS.
2. REDUCED PRESSURE PRINCIPLE BACKFLOW PREVENTION DEVICES ARE NOT PERMITTED IN BELOW GRADE CHAMBERS.
3. REFER TO HRWC SUPPLEMENTARY STANDARD SPECIFICATION FOR ABOVE GROUND HEATED ENCLOSURE REQUIREMENTS.
4. REFER TO HWS-002 AND HWS-003 FOR THE APPLICABLE PROFILE ARRANGEMENT.

2	NEW DETAIL FOR 2018	04/27/18	ST	JD	
1	NEW DETAIL FOR 2017	08/05/17	ST	KG	
No.	DESCRIPTION	DATE	BY	CHKD	

NOTE:  
ALL DIMENSIONS SHOWN IN MILLIMETERS,  
UNLESS OTHERWISE NOTED.



PROJECT		PLAN OF 15mm TO 50mm (5/8" TO 2") WATER METER & BACKFLOW PREVENTION DEVICE EXTERIOR CHAMBER ARRANGEMENT	
DRAWN	S.T.	SCALE (PLAN)	N.T.S.
CHECKED	J.D.	SCALE (PROFILE)	
APPROVED	K.G.	DATE	08/05/17
PROJECT No.			
DWG. No.		HWS - 005	

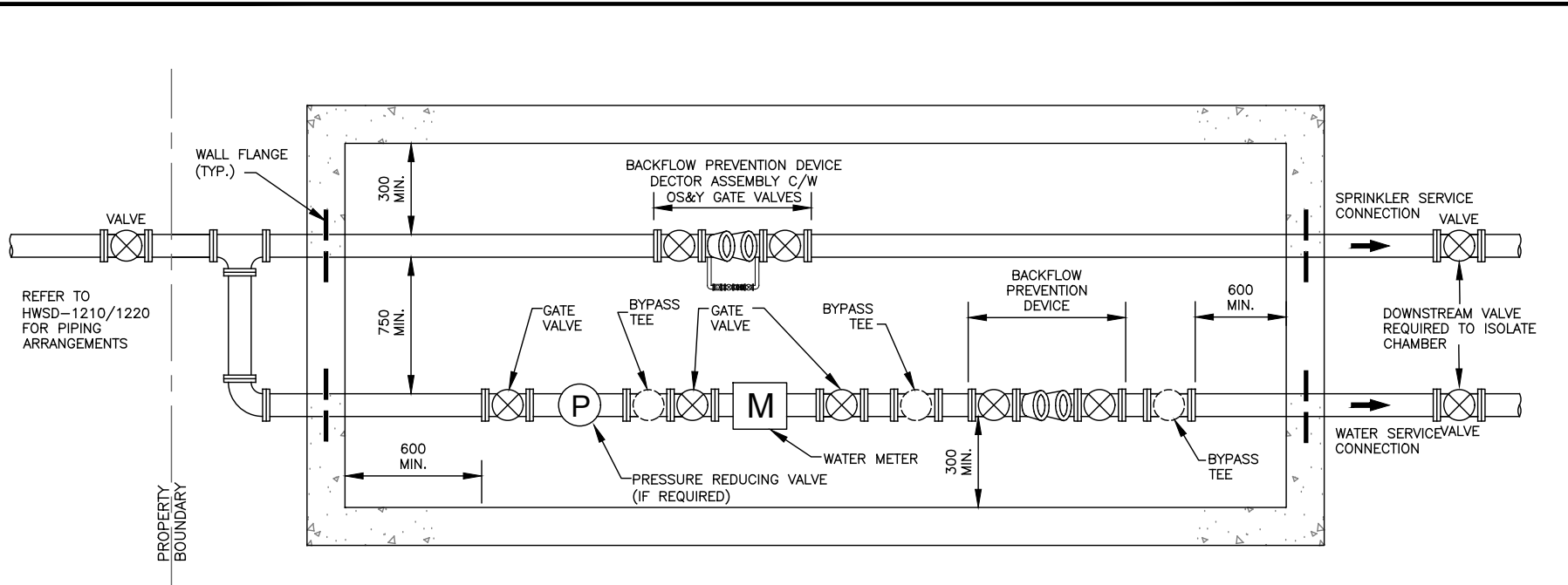

- NOTES:
1. ALL NOTED DIMENSIONS / SPACING REQUIREMENTS WITH REGARDS TO CHAMBER WALLS.
  2. REDUCED PRESSURE PRINCIPLE BACKFLOW PREVENTION DEVICES ARE NOT PERMITTED IN BELOW GRADE CHAMBERS.
  3. REFER TO HRWC SUPPLEMENTARY STANDARD SPECIFICATION FOR ABOVE GROUND HEATED ENCLOSURE REQUIREMENTS.
  4. REFER TO HWS-004 FOR THE PROFILE ARRANGEMENT.

2	NEW DETAIL FOR 2018	04/27/18	ST	JD	
1	NEW DETAIL FOR 2017	08/05/17	ST	KG	
No.	DESCRIPTION	DATE	BY	CHKD	

NOTE:  
ALL DIMENSIONS SHOWN IN MILLIMETERS,  
UNLESS OTHERWISE NOTED.



PROJECT	
PLAN OF 75mm(3") & GREATER WATER METER AND BACKFLOW PREVENTION DEVICES WITH BYPASS EXTERIOR CHAMBER ARRANGEMENT	
DRAWN S.T.	SCALE (PLAN) N.T.S.
CHECKED J.D.	SCALE (PROFILE)
APPROVED K.G.	DATE 08/05/17
PROJECT No.	
DWG. No. HWS - 006	

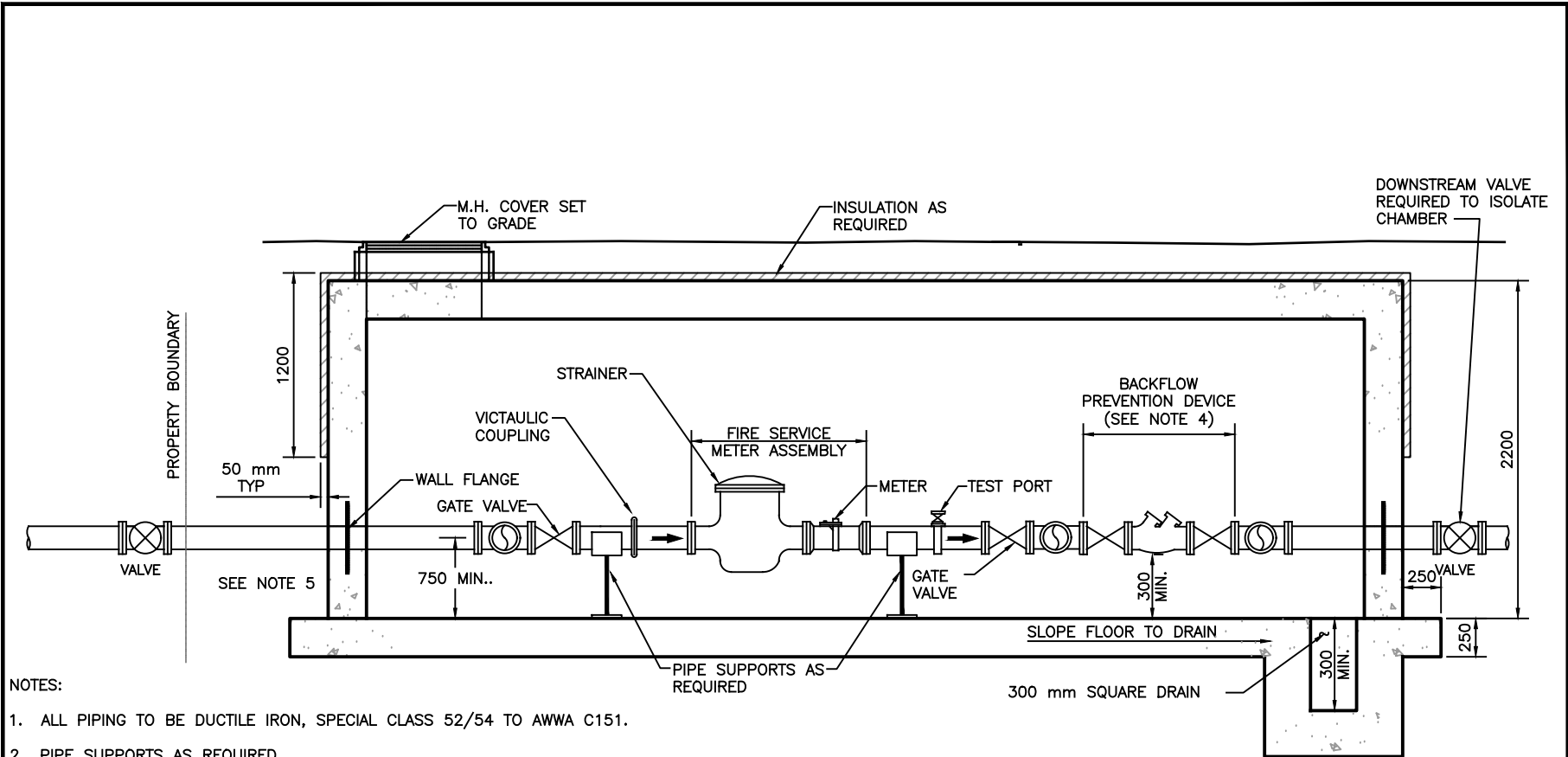

NOTES:

1. ALL PIPING TO BE DUCTILE IRON, SPECIAL CLASS 52/54 TO AWWA C151.
2. PIPE SUPPORTS AS REQUIRED.
3. M.H. COVER = HRWC SPEC, IMP R-90 PROVIDE 45 mm $\phi$  HOLE AND 100 mm $\phi$ -6 mm DEPTH COUNTERSINK IN COVER FOR REMOTE METER REGISTER.
4. PIPEWORK TO BE DESIGNED TO ACCOMMODATE POTENTIAL DIFFERENTIAL SETTLEMENT OF STRUCTURE.
5. REDUCED PRESSURE PRINCIPLE BACKFLOW PREVENTION DEVICES ARE NOT PERMITTED IN BELOW GRADE CHAMBERS. REFER TO HRWC SUPPLEMENTARY STANDARD SPECIFICATION FOR ABOVE GROUND HEATED ENCLOSURE REQUIREMENTS.

No.	DESCRIPTION	DATE	BY	CHKD
2	NEW DETAIL FOR 2018	04/27/18	ST	JD
1	NEW DETAIL FOR 2017	08/05/17	ST	KG

NOTE:  
ALL DIMENSIONS SHOWN IN MILLIMETERS,  
UNLESS OTHERWISE NOTED.



PROJECT		PROFILE MASTER WATER METER CHAMBER	
DRAWN	S.T.	SCALE	(PLAN)
CHECKED	J.D.	SCALE	(PROFILE) N.T.S.
APPROVED	K.G.	DATE	08/05/17
PROJECT No.			
DWG. No.		HWSD - 007	

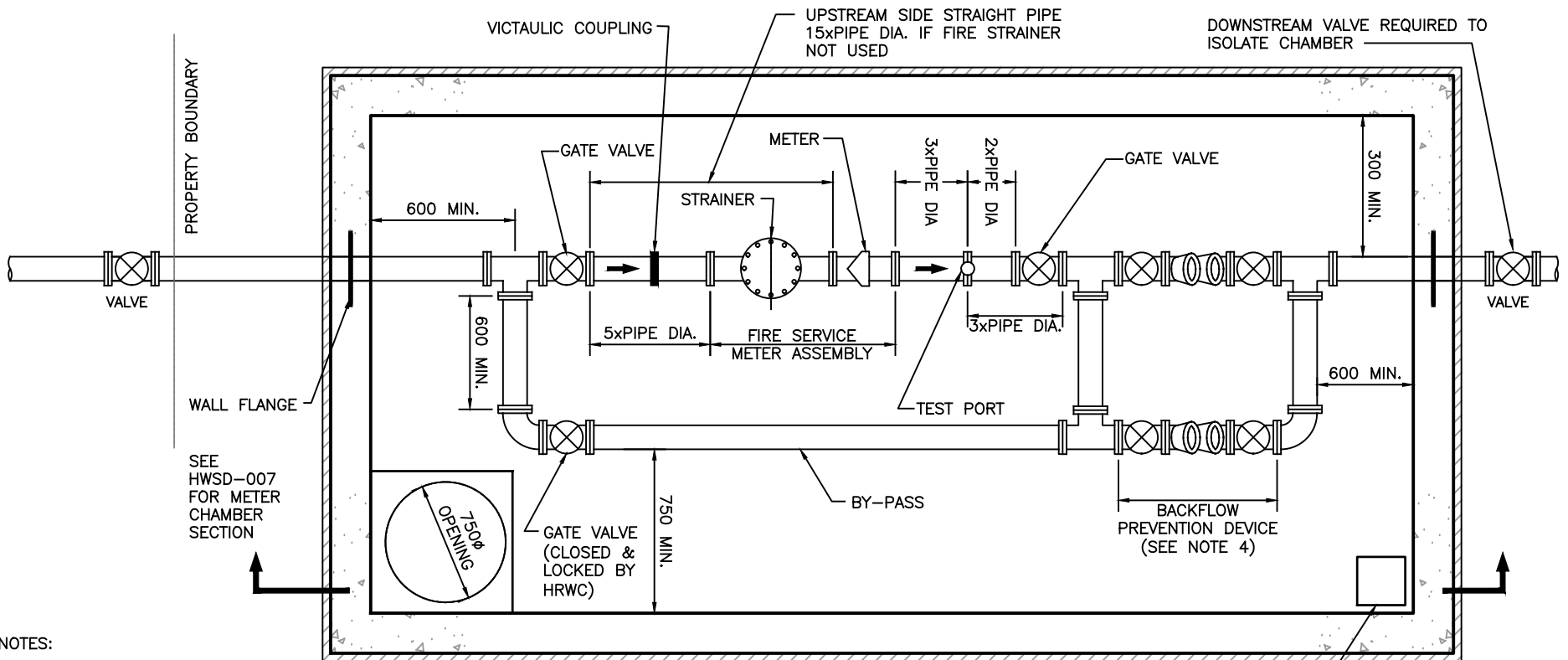

NOTES:

1. ALL PIPING TO BE DUCTILE IRON, SPECIAL
2. CLASS 52/54 TO AWWA C151.
3. PIPE SUPPORTS AS REQUIRED.
4. M.H. COVER = HRWC SPEC, IMP R-90. PROVIDE 45mm $\phi$  HOLE AND 100 mm $\phi$ -6 mm DEPTH COUNTERSINK IN COVER FOR REMOTE METER REGISTER.
5. REDUCED PRESSURE PRINCIPLE BACKFLOW PREVENTION DEVICES ARE NOT PERMITTED IN BELOW GRADE CHAMBERS.
6. REFER TO HRWC SUPPLEMENTARY STANDARD SPECIFICATION FOR ABOVE GROUND HEATED ENCLOSURE REQUIREMENTS.

300 mm SQUARE DRAIN. MINIMUM DEPTH 300 mm BELOW FLOOR SURFACE.

No.	DESCRIPTION	DATE	BY	CHKD
2	NEW DETAIL FOR 2018	18 04 27	ST	JD
1	NEW DETAIL FOR 2017	98 01 22	ST	KG

NOTE:  
ALL DIMENSIONS SHOWN IN MILLIMETERS,  
UNLESS OTHERWISE NOTED.



PROJECT			
<b>PLAN MASTER WATER METER CHAMBER</b>			
DRAWN	S.T.	SCALE (PLAN)	N.T.S.
CHECKED	J.D.	SCALE (PROFILE)	
APPROVED	K.G.	DATE	08/05/17
PROJECT No.			
DWG. No. <b>HWSD - 008</b>			



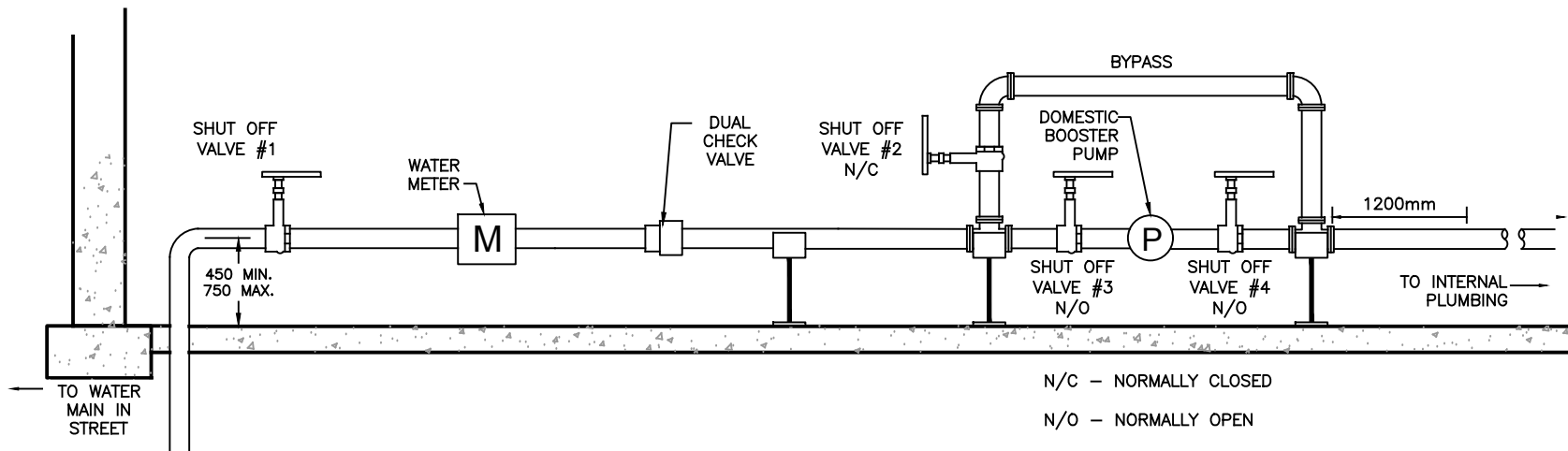

**NOTES:**

1. ALL PRODUCTS AND MATERIALS ARE REQUIRED TO BE NSF-61 COMPLIANT.
2. DOMESTIC BOOSTER PUMP SIZING AND PRODUCT SPECIFICATION AS PER BUILDING PLUMBING DESIGNER.
3. MINIMUM WATER SERVICE CONNECTION DIAMETER IS 25 mm.
4. REFER TO HWSD-001, HWSD-002 OR HWSD-003 FOR THE APPLICABLE PROFILE ARRANGEMENT.
5. ALL PIPE MATERIAL IS REQUIRED TO BE TYPE K COPPER TUBING TO ASTM B88.
6. FOR PEX<sub>a</sub> WATER SERVICE CONNECTIONS, USE ASTM 2080 COMPRESSION SLEEVE FITTING TO TRANSITION TO THE COPPER TUBING OF THE WATER METER ARRANGEMENT.
7. ARRANGEMENT IS TO BE NO LESS THAN 450 mm AND NO MORE THAN 750mm FROM THE FLOOR.
8. MINIMUM OF 1200 mm STRAIGHT LENGTH OF TYPE K COPPER TUBING DOWNSTREAM OF BY PASS ARRANGEMENT SECURE THE COPPER TUBING TO THE WALL OR FLOOR.
9. THE ARRANGEMENT IS REQUIRED TO BE HORIZONTALLY LEVEL AND HAVE SUFFICIENT ROOM FOR ACCESS.
10. PROVIDE 3/4" CONDUIT THROUGH FOUNDATION OR EXTERIOR WALL CLOSEST TO THE WATER METER FOR PURPOSE OF INSTALLING AN OUTSIDE REMOTE. PROVIDE SOLID 22 GAUGE, 3 OR 4 STRANDED CONDUCTOR WIRE FROM THE WATER METER TO THE EXTERIOR LOCATION FOR THE OUTSIDE REMOTE.
11. INSTALL OUTSIDE REMOTE ON THE DRIVEWAY SIDE OF THE BUILDING OR WHERE DIRECTED BY HRWC.
12. ALL COMPONENTS ILLUSTRATED MUST BE INSTALLED PRIOR TO THE WATER METER INSTALLATION.
13. THE BUILDING IS REQUIRED TO BE ROOF TIGHT, WITH EXTERIOR SIDING INSTALLED, AND THE CURB STOP AND SERVICE BOX ARE TO BE PLUMB AND LEVEL WITH FINISHED LANDSCAPING PRIOR TO WATER METER INSTALLATION.

1	NEW DETAIL FOR 2017	08/05/17	ST	KG	
No.	DESCRIPTION	DATE	BY	CHKD	

**NOTE:**  
ALL DIMENSIONS SHOWN IN MILLIMETERS, UNLESS OTHERWISE NOTED.



<b>PROJECT</b>		<b>PROFILE RESIDENTIAL BOOSTER PUMP ARRANGEMENT</b>	
DRAWN	S.T.	SCALE	(PLAN)
CHECKED	J.D.	SCALE	(PROFILE) N.T.S.
APPROVED	K.G.	DATE	08/05/17
PROJECT No.			
DWG. No. <b>HWSD - 009</b>			

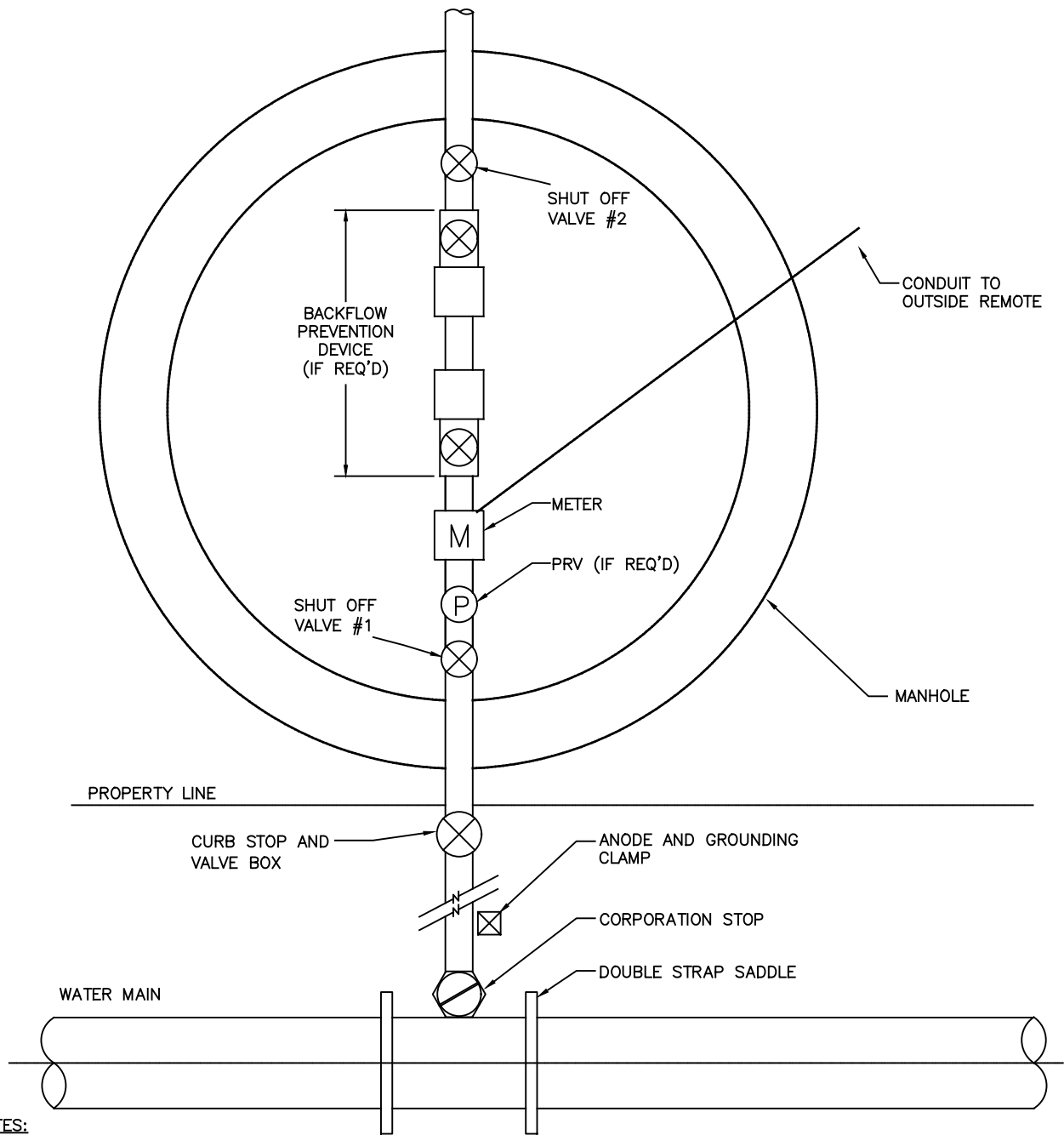

**NOTES:**

1. ALL PIPE, MANHOLE, FRAME AND COVER, VALVES AND FITTINGS TO BE SUPPLIED BY CONTRACTOR.
2. MANHOLE 2400 mm WITH B.F.P, 1800 mm WITHOUT B.F.P.
3. CONTRACTOR TO INSTALL CONDUIT AND SUPPORT/PROTECTION FOR REMOTE REGISTER, SUBJECT TO HRWC APPROVAL.
4. MINIMUM DEPTH OF METER FROM FINISHED GRADE 1600 mm.
5. INSULATION IS REQUIRED. SEE HWS-1310 FOR DETAILS.
6. SEE HWS-1180 FOR INSTALLATION OF SERVICES 38 mm AND OVER.
7. SEE HWS-1310 FOR PRECAST CONCRETE CHAMBER DETAILS
8. SEE HWS-1460 FOR MANHOLE FRAME AND COVER DETAILS
9. SEE HWS-001, HWS-002 OR HWS-003 FOR WATER METER ARRANGEMENT REQUIREMENTS.

No.	DESCRIPTION	DATE	BY	CHKD
1	NEW UPDATE FOR 2018 SPEC.	05/07/18	ST	JD
1	NEW DETAIL FOR 2017 SPEC.	08/05/17	ST	KG

**NOTE:**  
ALL DIMENSIONS SHOWN IN MILLIMETERS, UNLESS OTHERWISE NOTED.



**PROJECT**  
PLAN OF 15mm TO 50mm  
(5/8" TO 2")  
WATER METER PIT

DRAWN	J.W.	SCALE (PLAN)	N.T.S.
CHECKED	J.D.	SCALE (PROFILE)	
APPROVED	K.G.	DATE	08/05/17

PROJECT No.  
DWG. No. HWS - 010 (2018)

**NOTES:**

1. NUMBER OF SUPPORTS NEEDED BASED ON PIPE SIZE.
2. ALL COMPONENTS OF THE PIPE SUPPORT SHALL BE "HOT DIPPED GALVANIZED"

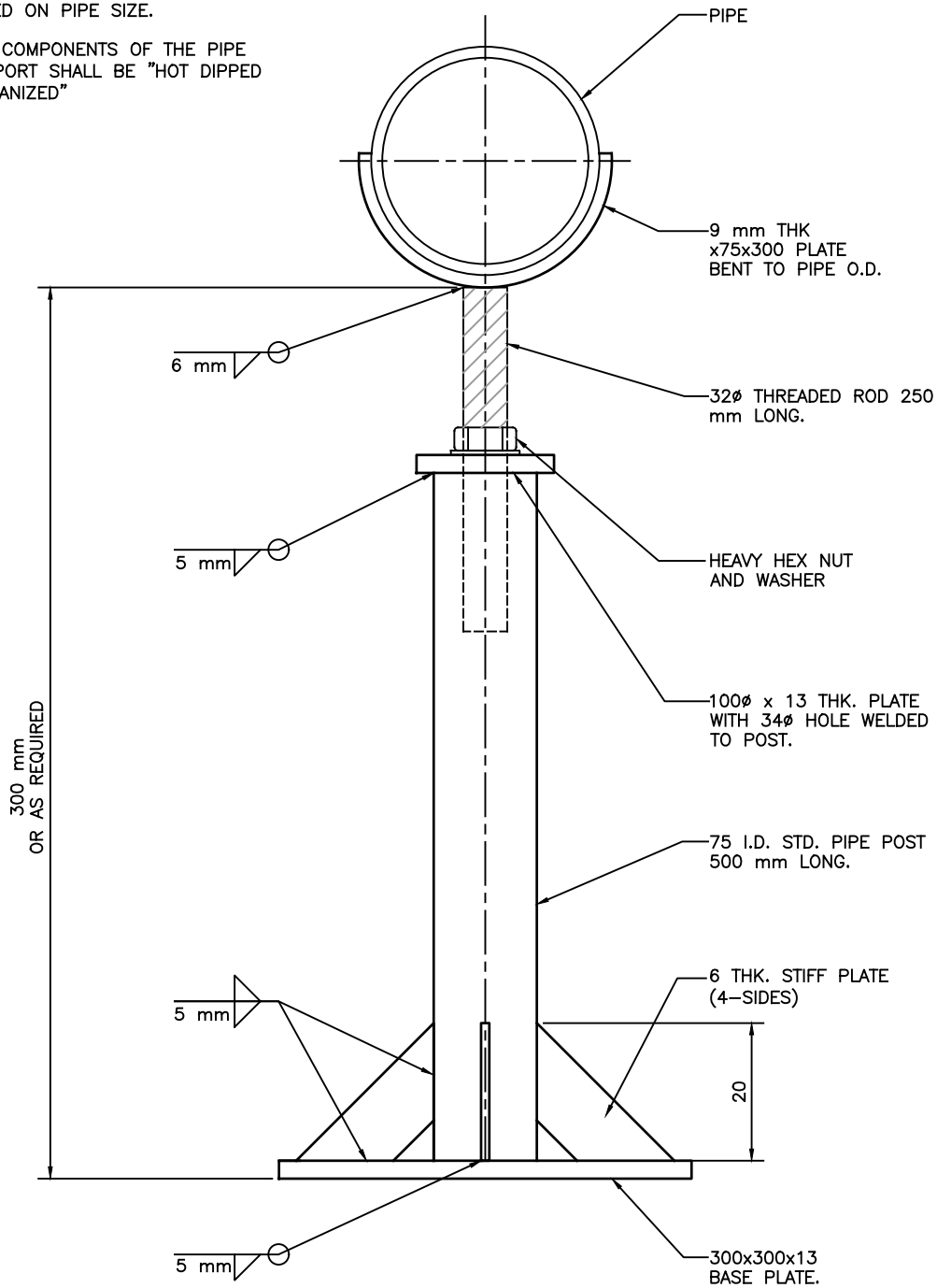

1	NEW DETAIL FOR 2017 SPEC	08/05/17	ST	KG
No.	DESCRIPTION	DATE	BY	CHKD

**NOTE:**  
ALL DIMENSIONS SHOWN IN MILLIMETERS,  
UNLESS OTHERWISE NOTED.



PROJECT	
PIPE SUPPORT DETAIL	
DRAWN S.T.	SCALE (PLAN)
CHECKED J.D.	SCALE (PROFILE) N.T.S.
APPROVED K.G.	DATE 08/05/17
PROJECT No.	
DWG. No. HWSD - 011	